

# PRODUCT SPECIFICATION

DATE:03/24/2004

<b>cosmo</b> ELECTRONICS CORPORATION	Photocoupler : <b>KMOC3081</b>	NO.60P42005	REV.
		SHEET 1 OF 6	2

## Zero Crossing Optoisolators TRIAC

Driver Output (800V Volts Peak)

### ●Features

1. Compact dual-in-line package.
2. 800V peak blocking voltage.
3. Isolation voltage between input and output (Viso:5000Vrms).

### ●For 115/240 Vac(rms) Application:

1. Solenoid/Valve Controls.
2. Lighting Controls.
3. Static Power Switches.
4. AC Motor Drives.
5. Temperature Controls.
6. E.M. Contactors.
7. AC Motor Staters.
8. Solid State Relays.
9. Programmable controllers.

# PRODUCT SPECIFICATION

DATE:03/24/2004

<b>cosmo</b> ELECTRONICS CORPORATION	Photocoupler : <b>KMOC3081</b>	NO.60P42005	REV. 2
		SHEET 2 OF 6	

## 1. OUTSIDE DIMENSION : UNIT (mm)

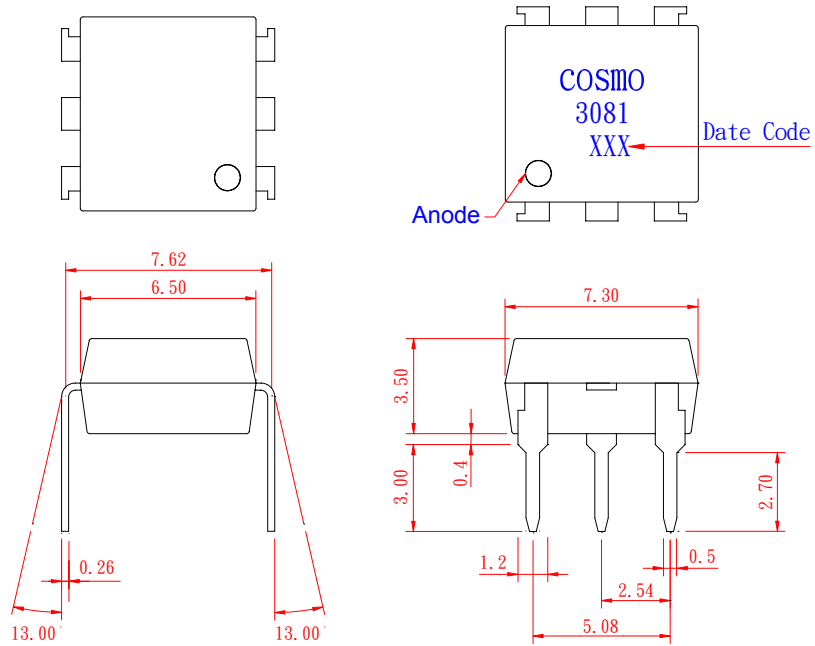

TOLERANCE :  $\pm 0.2\text{mm}$

## 2. SCHEMATIC : TOP VIEW

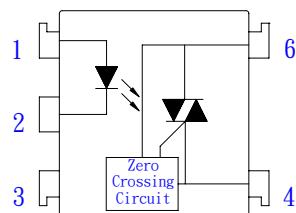

- 1. Anode
- 2. Cathode
- 3. NC
- 4. Main Terminal
- 6. Main Terminal

# PRODUCT SPECIFICATION

DATE:03/24/2004

<b>cosmo</b> ELECTRONICS CORPORATION	Photocoupler : <b>KMOC3081</b>	NO.60P42005	REV. 2
		SHEET 3 OF 6	

## ●Absolute Maximum Ratings

	Parameter	Symbol	Rating	Unit
Input	Forward current	$I_F$	50	mA
	Peak forward current	$I_{FM}$	1	A
	Reverse voltage	$V_R$	6	V
	Power dissipation	$P_D$	70	mW
Output	Off-State Output Terminal voltage	$V_{DRM}$	800	$V_{PEAK}$
	On-State R.M.S. Current	$I_{T(RMS)}$	100	mA
	Peak Repetitive Surget Current (PW=10ms.DC 10%)	$I_{TSM}$	1	A
	Power dissipation	$P_D$	300	mW
	Total power dissipation	$P_{tot}$	330	mW
	Isolation voltage 1 minute	$V_{iso}$	5000	$V_{rms}$
	Operating temperature	$T_{opr}$	-40 to +80	°C
	Storage temperature	$T_{sta}$	-40 to +125	°C
	Soldering temperature 10 second	$T_{sol}$	260	°C

## ●Electro-optical Characteristics

	Parameter	Symbol	Conditions	MIN.	TYP.	MAX.	Unit
Input	Forward voltage	$V_F$	$I_F=10mA$	-	1.2	1.4	V
	Reverse current	$I_R$	$V_R=4V$	-	-	10	uA
Output	Peak Blocking Current	$I_{DRM}$	$V_{DRM}=800V$	-	60	500	nA
	ON-State Voltage	$V_{TM}$	$I_{TM}=100mA$	-	1.8	3	V
Transfer characteristics	Holding Current	$I_H$		-	100	-	uA
	Critical rate of rise of OFF-state voltage	$dV/dt$	$V_{DRM}=(1/\sqrt{2})*Rated$	600	-	-	V/uS
	Inhibit Voltage(MT1-MT2 Voltage above which device not trigger)	$V_{INH}$	$I_F=Rated I_{FT}$	-	8	20	V
	Leakage in Inhibited State	$I_{DRM2}$	$I_F=Rated I_{FT}, Rated V_{DRM}, Off State$	-	-	500	uA
	Isolation resistance	$R_{iso}$	DC500V	$5 \times 10^{10}$	$10^{11}$	-	ohm
	Minimum trigger current	$I_{FT}$	Main Terminal Voltage=3V	-	-	15	mA

# PRODUCT SPECIFICATION

DATE:03/24/2004

<b>cosmo</b> ELECTRONICS CORPORATION	Photocoupler :	NO.60P42005	REV. 2
	<b>KMOC3081</b>	SHEET 4 OF 6	

Fig.1 Forward Current vs. Ambient Temperature

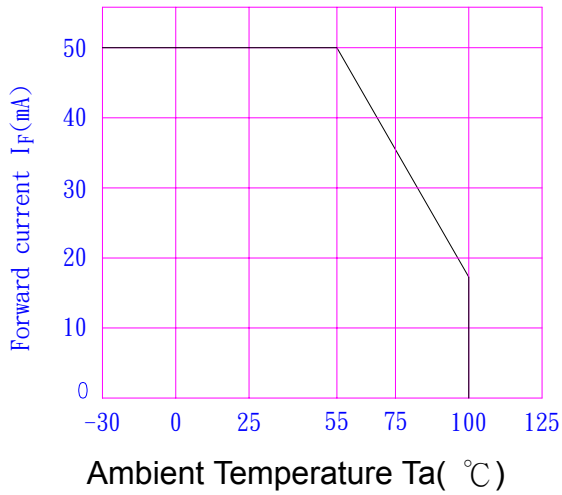

Fig.2 Diode Power Dissipation vs. Ambient Temperature

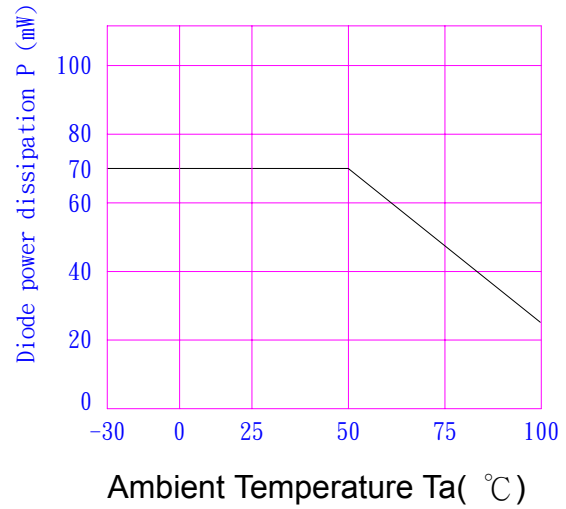

Fig.3 On-State R.M.S. Current vs. Ambient Temperature

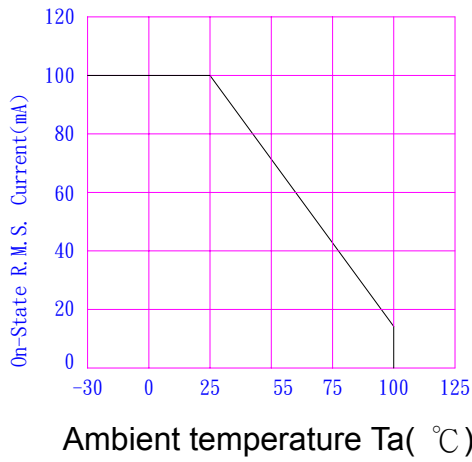

Fig.4 Total Power Dissipation vs. Ambient Temperature

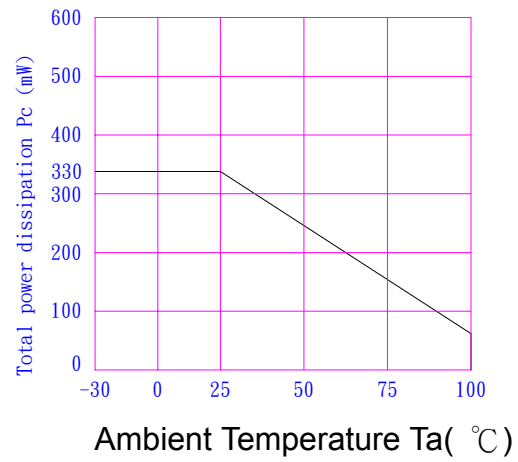

Fig.5 Peak Forward Current vs. Duty Ratio

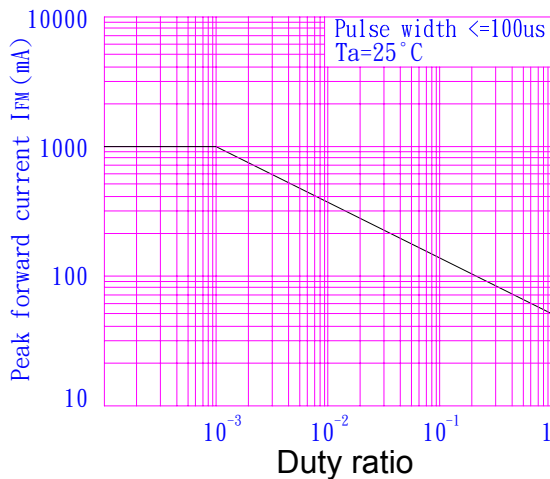
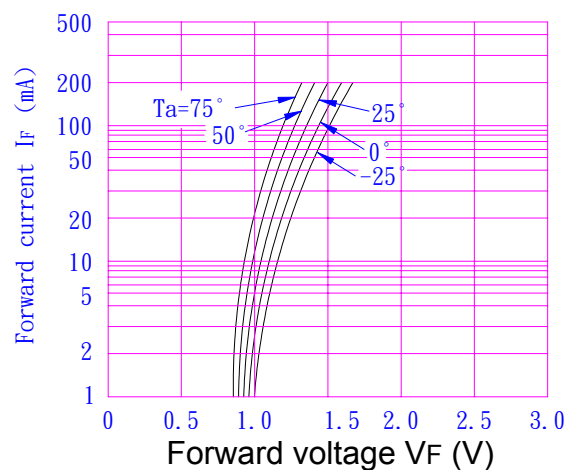

Fig.6 Forward Current vs. Forward Voltage



# PRODUCT SPECIFICATION

DATE:03/24/2004

<b>cosmo</b> ELECTRONICS CORPORATION	Photocoupler : <b>KMOC3081</b>	NO.60P42005	REV. 2
		SHEET 5 OF 6	

Fig.7 On-State Characteristics

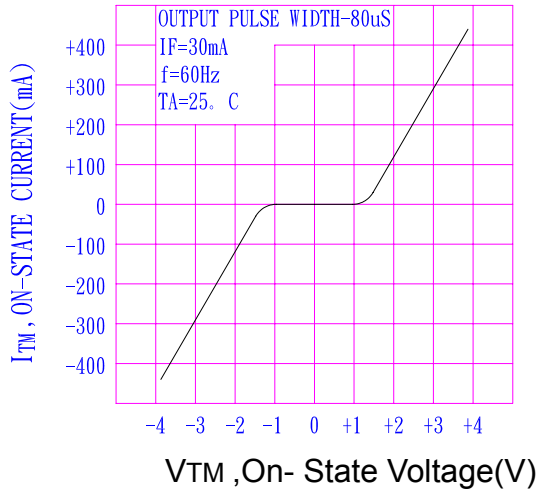

Fig.8 Inhibit Voltage vs. Temperature

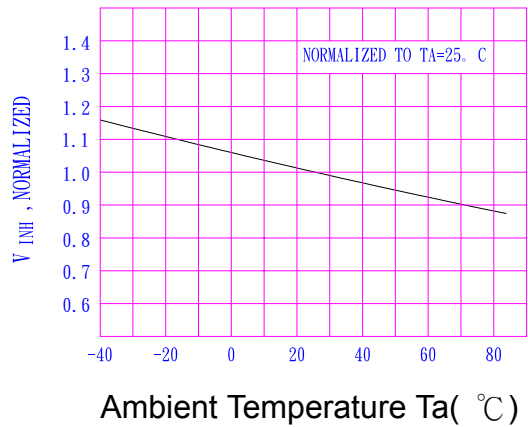

Fig.9 Leakage with LED Off vs. Temperature

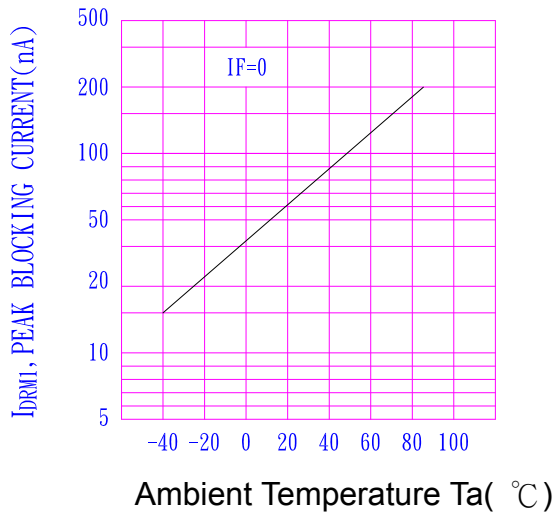

Fig.10 I\_DRM2, Leakage in Inhibit State vs. Temperature

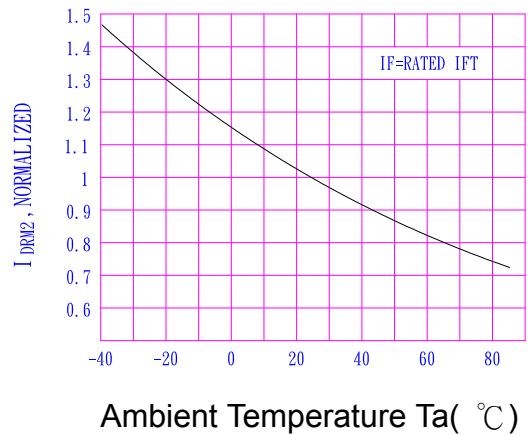
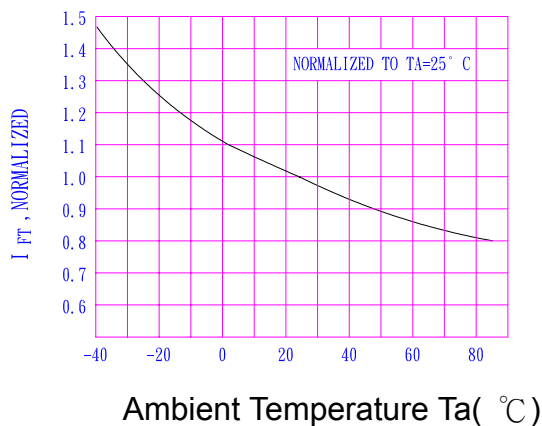

Fig.11 Trigger Current vs. Temperature



# PRODUCT SPECIFICATION

DATE: 03/24/2004

<b>cosmo</b> ELECTRONICS CORPORATION	Photocoupler : <b>KMOC3081</b>	NO.60P42005	REV.
		SHEET 6 OF 6	2

## NOTICE

The information contained in this document is intended to be a general product description and is subject to change without notice. Please contact cosmo in order to obtain the latest device data sheets before using any cosmo device. cosmo does not assume any responsibility for use of any circuitry described. No circuit patent licenses are implied. This publication is the property of cosmo . No part of this publication may be reproduced or copied in any form or by any means, or transferred to any third party without the prior written consent of cosmo Electronics Corporation.

The devices listed in this document are designed for general applications only in electronic equipment. No devices shall be deployed which require higher level of reliability such as:

- Medical and other life support equipments.
- Space application.
- Telecommunication equipment (trunk lines).
- Nuclear power control equipment.

Unless it received prior written approval from cosmo.

cosmo takes no responsibility for damages arise form the improper usage of our device. Please contact cosmo for further information regarding the above notices.