

PRODUCT SPECIFICATION

DATE: 03/17/2003

COSMO ELECTRONICS CORPORATION	Photocoupler : KTLP260J	NO. 61P43004	REV.
		SHEET 1 OF 6	1

Mini-flat package
Optoisolators Triac Driver Output
(600V Volts Peak)

● Features

1. Opaque type, mini-flat package.
2. Subminiature type

(The volume is smaller than that of our conventional DIP type by as far as 30%)
4. Isolation voltage between input and output (Viso:3000Vrms).

● For 115/240 Vac(rms) Application:

1. Solenoid/Valve Controls.
2. Lighting Controls.
3. Static Power Switches.
4. AC Motor Drives.
5. Temperature Controls.
6. E. M. Contactors.
7. AC Motor Staters.
8. Solid State Relays.
9. Programmable controllers.

PRODUCT SPECIFICATION

DATE: 03/17/2003

COSMO ELECTRONICS CORPORATION	Photocoupler : KTLP260J	NO. 61P43004	REV.
		SHEET 2 OF 6	1

1. OUTSIDE DIMENSION : UNIT(mm)

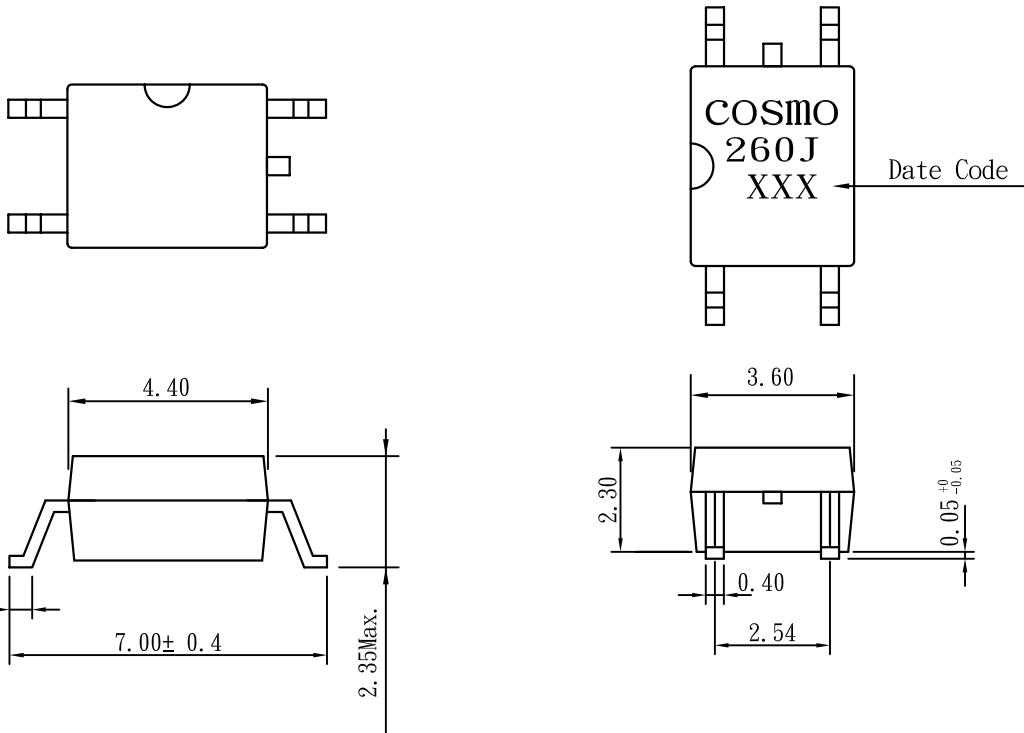

TOLERANCE : ± 0.2mm

2. SCHEMATIC : TOP VIEW

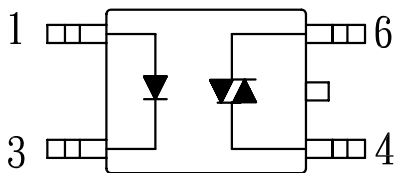

1. Anode
3. Cathode
4. MAIN TERMINAL
6. MAIN TERMINAL

PRODUCT SPECIFICATION

DATE: 03/17/2003

COSMO ELECTRONICS CORPORATION	Photocoupler : KTLP260J	NO. 61P43004	REV.
		SHEET 3 OF 6	1

• Absolute Maximum Ratings

(Ta=25° C)

	Parameter	Symbol	Rating	Unit
Input	Forward current	IF	50	mA
	Peak forward current(100us)	IFM	1	A
	Reverse voltage	VR	6	V
	Power dissipation	PD	70	mW
Output	Off-State Output Terminal voltage	VDRM	600	Vpeak
	On-State R. M. S. Current	IT(RMS)	70	mA
	Peak Repetitive Surget Current(PW=10ms, DC 10%)	ITSM	1	A
	Power Dissipation	PD	150	mW
	Total power dissipation	Ptot	200	mW
	Isolation voltage 1 minute	Viso	3000	Vrms
	Operating temperature	Topr	-40 to +100	° C
	Storage temperature	Tstg	-50 to +125	° C
	Soldering temperature 10 seconds	Tsol	260	° C

• Electro-optical Characteristics

(Ta=25° C)

	Parameter	Symbol	Conditions	MIN.	TYP.	MAX.	Unit
Input	Forward voltage	VF	IF=10mA	-	1.2	1.4	V
	Peak forward voltage	VFM	IFM=0.5A	-	-	3.5	V
	Reverse Leakage Current	IR	VR=5V	-	-	10	uA
Output	Peak Blocking Current	IDRM	VDRM=600V	-	-	1.0	uA
	ON-State Voltage	VTM	ITM=70mA	-	1.6	2.8	V
Transfer characteristics	Holding Current	IH		-	1.0	-	mA
	Critical rate of rise of OFF-state voltage	dV/dt	VDRM=(1/√2)*Rated	100	500	-	V/uS
	Isolation resistance	Riso	DC500V	5x10 ¹⁰	10 ¹¹	-	ohm
	Minimum trigger current	IFT	Main Terminal Voltage=3V	-	5	10	mA
	Turn-on time	Ton	Vp=6v, RL=100 ohm, IF=20mA	-	-	100	uS

Classification table of Trigger LED current

is shown below.

(Ta=25° C)

Classification	Trigger LED Current (mA)	
	Min.	Max.
1 (Standard)	-	10
2	-	7
3	-	5

PRODUCT SPECIFICATION

DATE: 03/17/2003

COSMO ELECTRONICS CORPORATION	Photocoupler : KTLP260J	NO. 61P43004	REV.
		SHEET 4 OF 6	1

Fig.1 Forward Current vs. Ambient Temperature

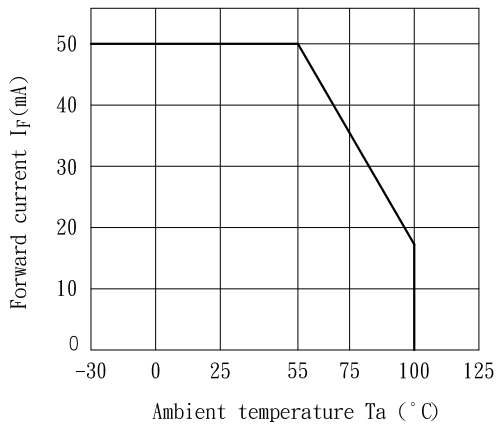

Fig.2 Diode Power Dissipation vs. Ambient Temperature

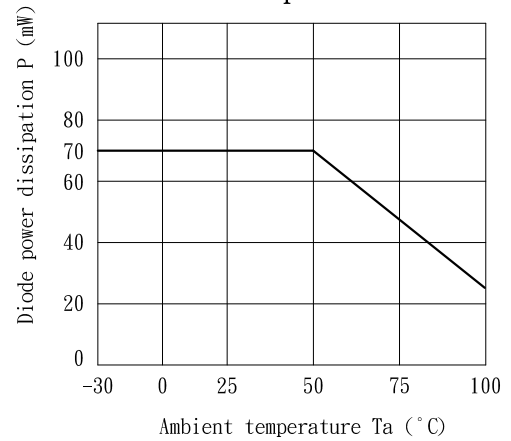

Fig.3 On-State R. M. S. Current vs. Ambient Temperature

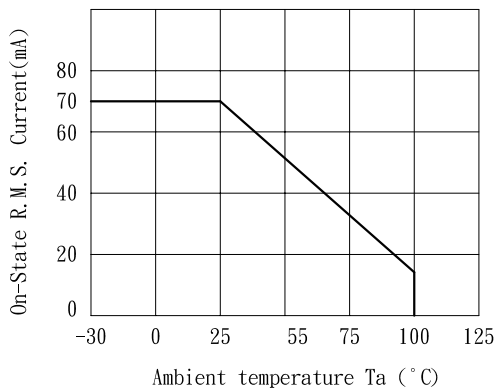

Fig.4 Total Power Dissipation vs. Ambient Temperature

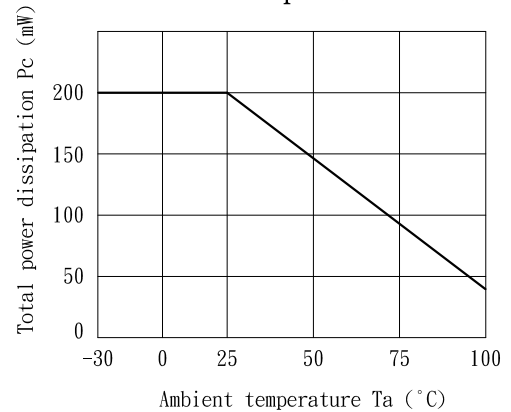

Fig.5 Peak Forward Current vs. Duty Ratio

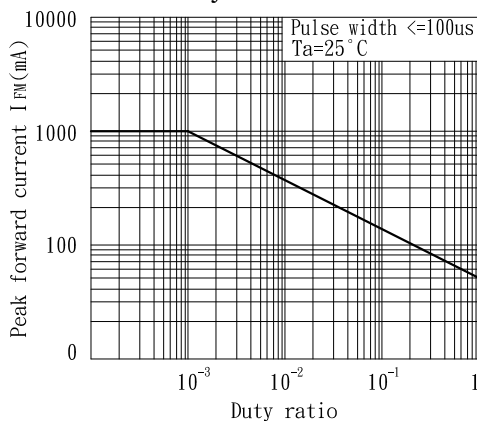
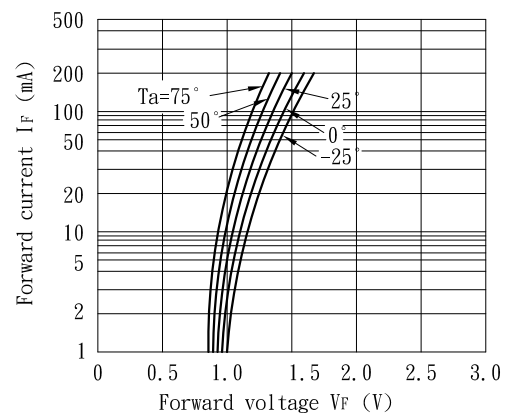

Fig.6 Forward Current vs. Forward Voltage



PRODUCT SPECIFICATION

DATE: 03/17/2003

COSMO ELECTRONICS CORPORATION	Photocoupler : KTLP260J	NO. 61P43004	REV.
		SHEET 5 OF 6	1

Fig. 7 On-State Characteristics

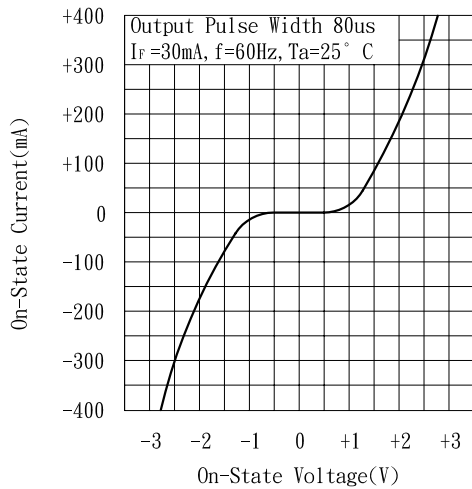

Fig. 8 Leakage with LED off vs. Ambient Temperature

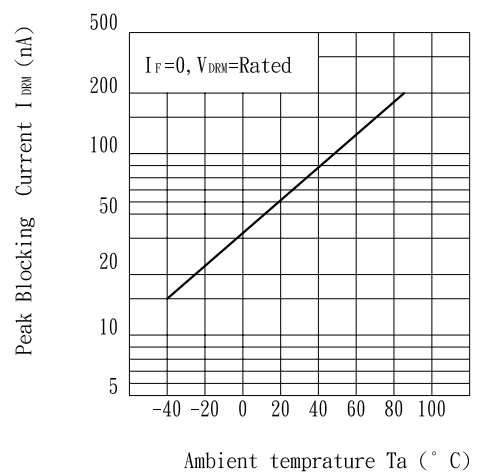
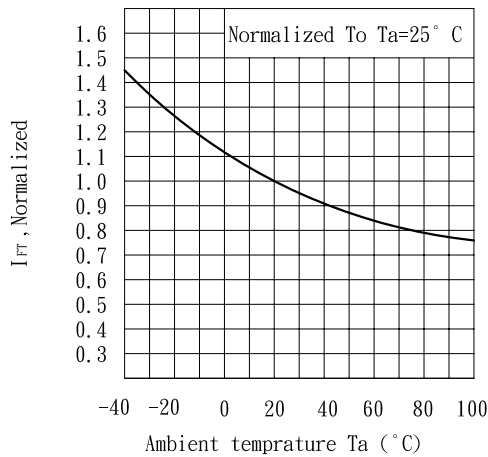

Fig. 9 Trigger Current vs. Ambient Temperature



PRODUCT SPECIFICATION

DATE: 03/17/2003

COSMO ELECTRONICS CORPORATION	Photocoupler : KTLP260J	NO. 61P43004	REV.
		SHEET 6 OF 6	1

NOTICE

The information contained in this document is intended to be a general product description and is subject to change without notice. Please contact cosmo in order to obtain the latest device data sheets before using any cosmo device. cosmo does not assume any responsibility for use of any circuitry described. No circuit patent licenses are implied. This publication is the property of cosmo . No part of this publication may be reproduced or copied in any form or by any means, or transferred to any third party without the prior written consent of cosmo Electronics Corporation.

The devices listed in this document are designed for general applications only in electronic equipment. No devices shall be deployed which require higher level of reliability such as:

- Medical and other life support equipments.
- Space application.
- Telecommunication equipment (trunk lines).
- Nuclear power control equipment.

Unless it received prior written approval from cosmo.

cosmo takes no responsibility for damages arise from the improper usage of our device . Please contact cosmo for further information regarding the above notices.